

Cast Iron Ring 3

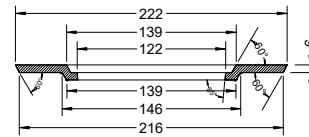

Cast Iron Ring 2

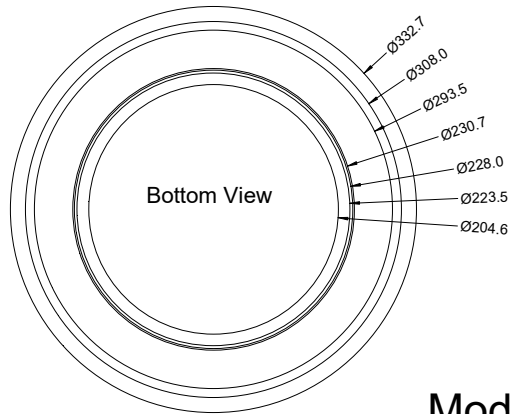
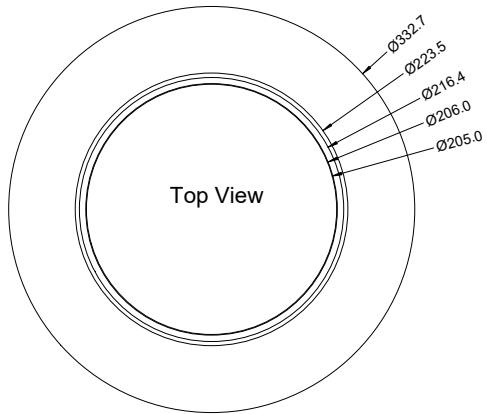
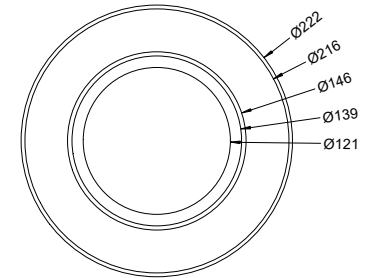
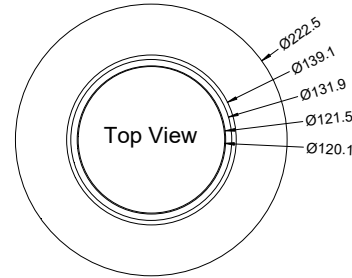

Model KG4 B
Version 1.2
13 Dec 2017

Dwg. KG4.4.12.23

C Pemberton-Pigott

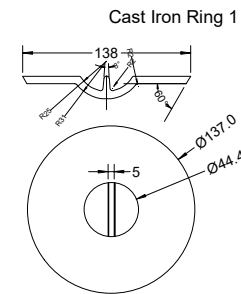

Cast Iron Ring 1

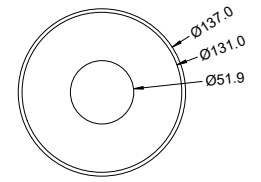
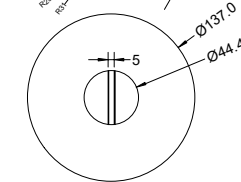

Bottom View

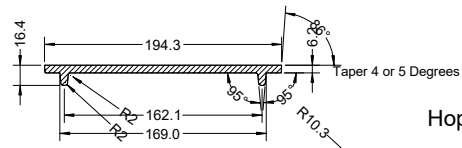

Hopper cover

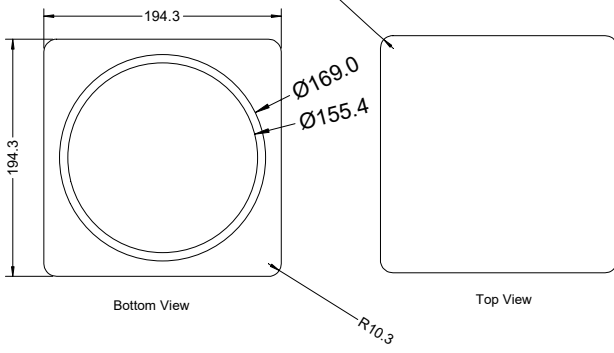

Casting Pattern Dimensions
for 3% shrinkage:
Wood -> Aluminum -> Cast Iron